



KONGSKILDE

OK Pipe System

OK/OKR/OKD

Kongskilde
OK Pipe System

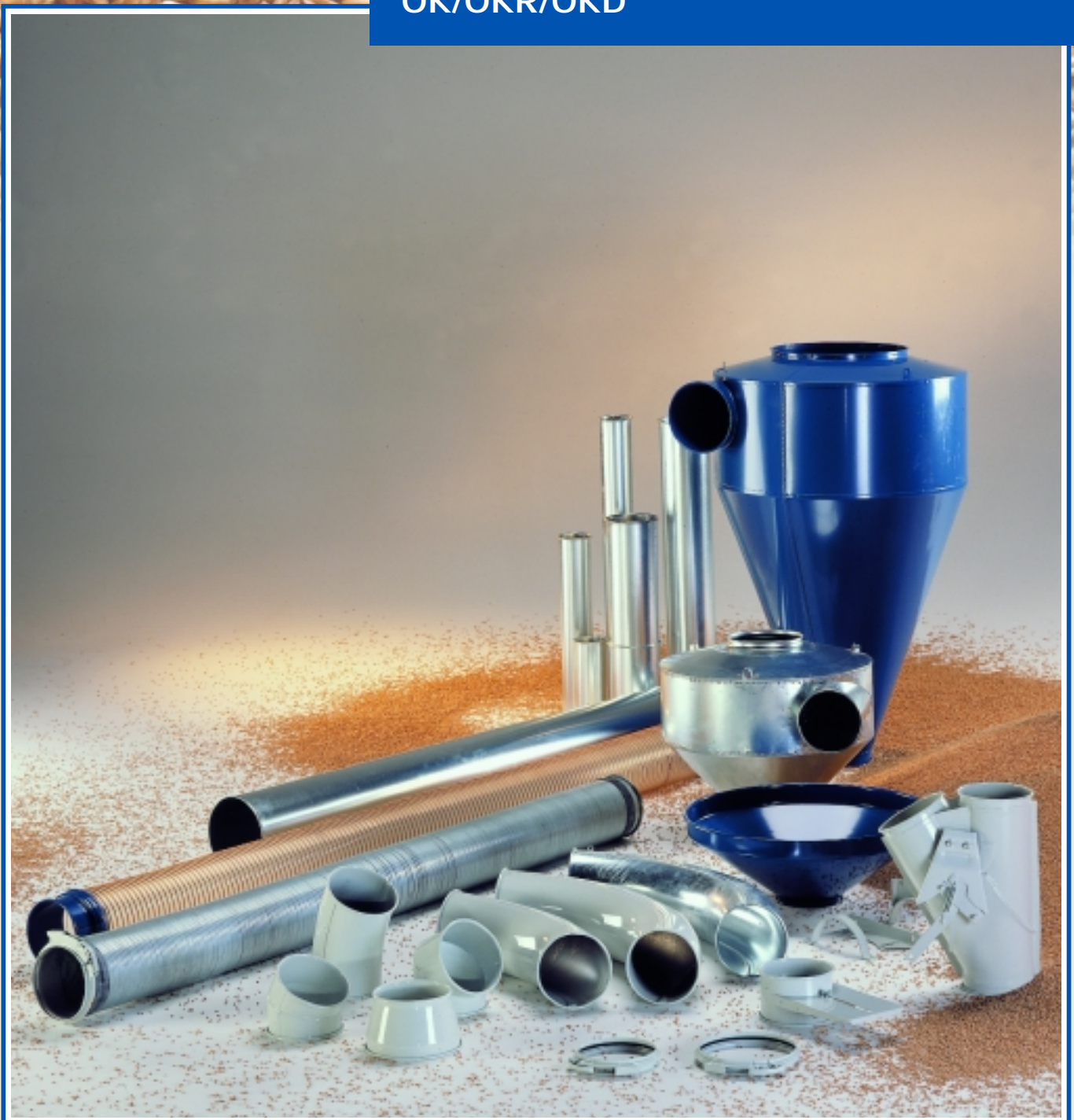

The OK pipe system is ideal for pneumatic and mechanical conveying and for ventilating applications in both farming and industry.

The simple and flexible pipe systems may be adjusted to suit any specific purpose, resulting in shorter conveying distances and therefore the most efficient and economical solutions.

Applications range from the conveying of crops, waste paper, plastic granulates and sawdust to complete ventilation systems.

Customized systems can be supplied - tailored to meet any specific requirement - whether for conveying or for ventilating.

Robust construction

Tight joints

The sturdily constructed OK pipe system is made from galvanized sheet steel. The rolled pipe ends serve as reinforcements, maintaining the circular shape and ensuring tight joints.

Three pipe diameters

The OK pipe system is available in three different diameters: OK 100 (100 mm), OK 160 (160 mm) and OK 200 (200 mm). The dimensions refer to the outside pipe diameters.

Selection of wall thicknesses

Choice of wall thickness depends largely on the wear to which the pipe system will be exposed. The wide range of pipes is therefore available in different thicknesses - OK standard,

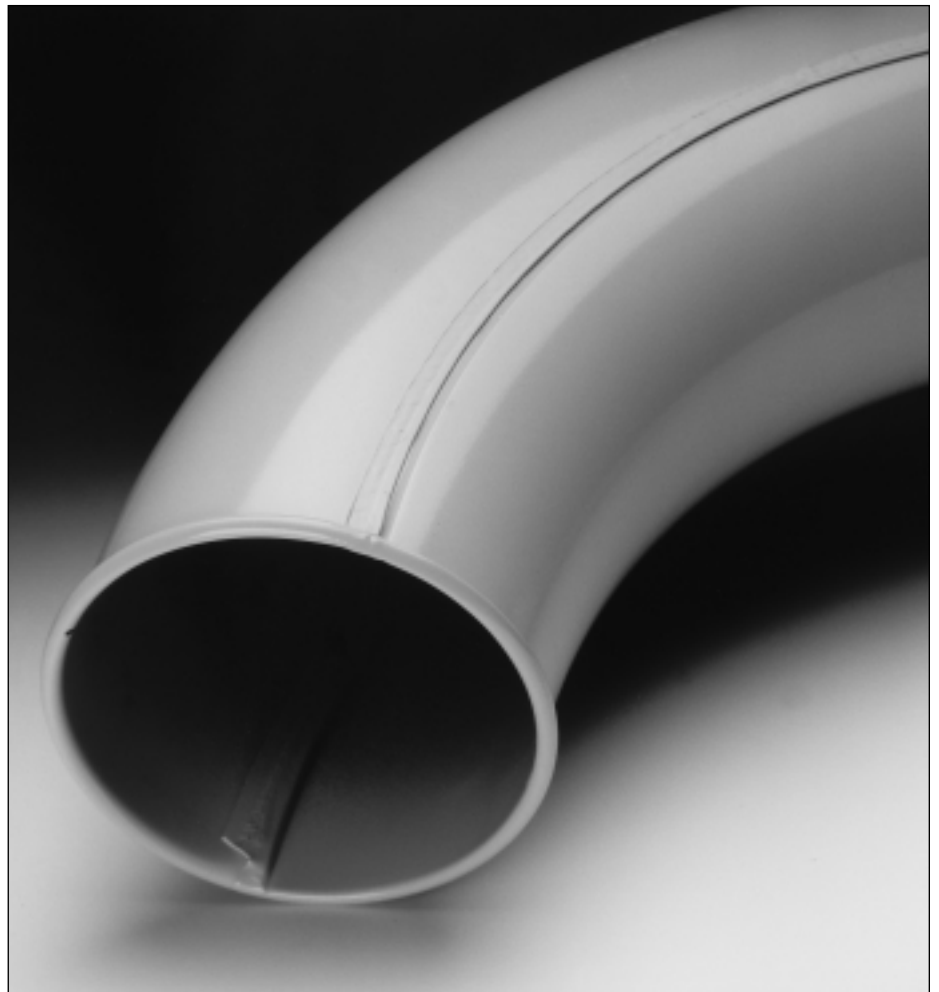

OKR reinforced and OKD extra reinforced (for gravity flow).

Full utilization of the air stream

The advanced production machinery ensures a continuous smooth inner

surface of the pipeline, thus giving gentle and efficient conveying - even in downpipes - as well as maximum utilization of the air stream.

Modular pipe system

Designed in modular form the OK pipe system comprises pipes, bends, branches, diverters, cyclones, outlets, etc. The components are assembled quickly and easily using the unique OK quick-release couplings. The wide choice of OK pipes and accessories

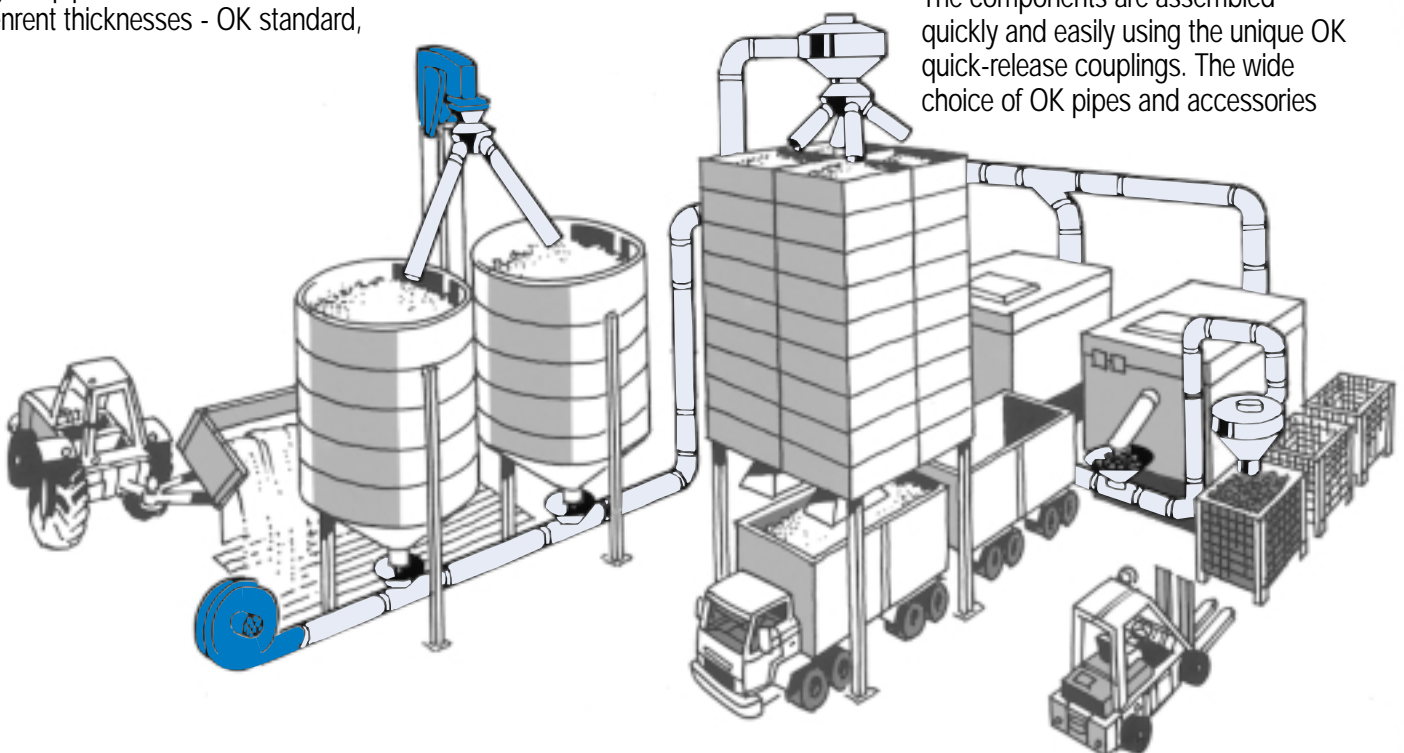



ensures flexibility and ease of installation in existing buildings.

Temporary and permanent installations

Two types of OK couplings are available for temporary and permanent systems, respectively.

If the pipe system is to be dismantled or altered frequently, it is advantageous to select the OK quick-release couplings for assembly and removal without the use of tools. The relatively low weight of the OK pipes facilitates assembly.

For permanent systems OK bolt couplings are preferable.

Saving floor space by wall or ceiling mounting

OK pipe supports permit wall and ceiling mounting, thus keeping clear valuable floor space in production premises or storage plants.

Economical in operation

The OK couplings make maintenance and alterations easy tasks. Worn-out parts are replaced and new components added when required. The OK pipe system is so complete that the requirement for special parts will be unlikely.

Modern technology

Competitive prices

The modern manufacturing technology together with the carefully devised modular design and the extensive use of standardized components ensures an efficient system at competitive prices. Enquiries for quotations, without obligation, are always welcome.

Easy ordering

Prompt delivery

The following pages give detailed technical information and order numbers of the individual items. To expedite delivery always quote these numbers, as all components are stock items.

Pneumatic conveying

OK - OKR

Exhaustion/Ventilation

OK

Downpipe system

OKD

Expertise and know-how

The company has supplied pneumatic pipe systems for over forty years. Such experience, of course, adds greatly to knowledge and expertise in this field. Do not hesitate to consult us for an economical solution that will not only meet the demands of today but will also be easy to alter to those of tomorrow.

Being one of the leading pipe system suppliers in Europe is both an obligation and a privilege.

OK 100

Pneumatic Conveying Exhaustion Ventilation

Outer diameter: 100 mm.

Clamps



Quick release clamp, grey.
122 040 162



Quick release clamp, galv.
122 040 165

Pipes

Thickness of sheet: 0,75 mm.

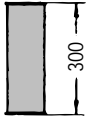

0,3 m pipe, galv.
122 040 119

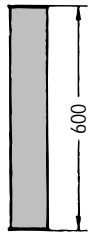

0,6 m pipe, galv.
122 040 118

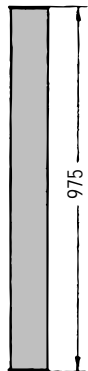

1 m pipe, galv.
122 040 117



2 m pipe, galv.
122 040 116

Telescopic pipe

Thickness of sheet: 0,75 mm

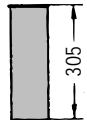

0,3 m telescopic pipe, galv.
122 040 172

Rubber ring
122 040 018

Bends

Thickness of sheet: ins./outs.: 1,0/1,0 mm.

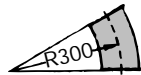

30° bend, grey.
122 040 124

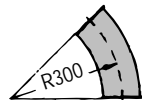

45° bend, grey.
122 040 122

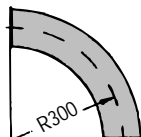

90° bend, grey.
122 040 120

Diverter

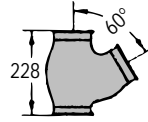

60° 2-way diverter, grey.
122 040 132

Branch pipe

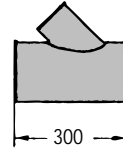

45° branch pipe, grey.
OK 160/100/160
131 025 052

Pipe support



Pipe support, galv.
122 040 174

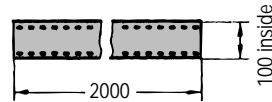

Pipe support extension, galv.
Length 2 m - may be shortened
at will.
131 025 094

Shutter



Shutter, grey. Shutter seal
131 025 048 131 025 050

Transition



Transition OK 100/160, grey.
122 000 308

Adaptor



OK 100 adaptor, galv.
122 040 131

Rubber seal



Rubber seal
(for sealing of OK 100 joint).
122 040 041

Silencer

The conveyed material may not pass
through the silencer.

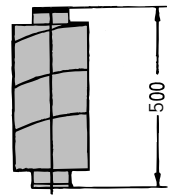

Silencer, galv.
125 500 525

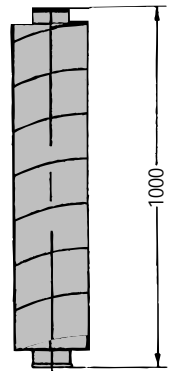

Silencer, galv.
125 500 551

OK 160

Pneumatic Conveying Exhaustion Ventilation

Outer diameter: 160 mm.

Clamps



Quick release clamp, grey.
122 000 780



Quick release clamp, galv.
122 000 800



Clamp with bolt, galv.
122 000 193



Bolt/quick release clamp, grey.
122 000 648

Pipes

Thickness of sheet: 0,9 mm.



0,06 m pipe, grey.
122 010 011

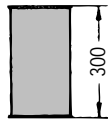

0,3 m pipe, galv.
122 010 010

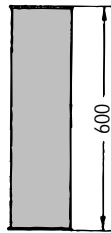

0,6 m pipe, galv.
122 010 008

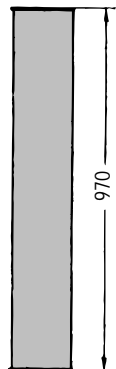

1 m pipe, galv.
122 010 007

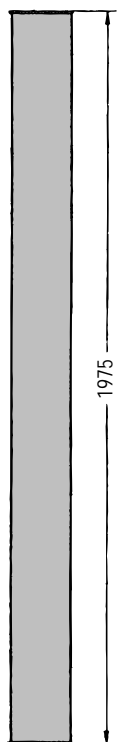

2 m pipe, galv.
122 010 006

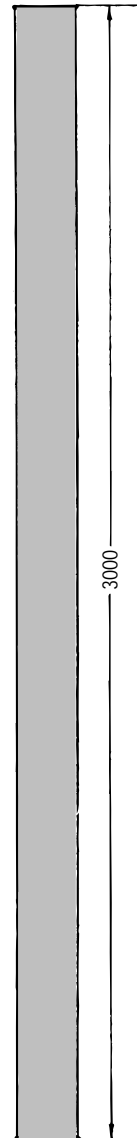

3 m pipe, galv.
122 010 076

Telescopic pipes

Thickness of sheet: 0,9 mm.



0,1 m telescopic pipe, galv.
122 000 681



0,5 m telescopic pipe, galv.
122 000 680



O-ring
122 000 132

Bends

Thickness of sheet: ins./outs.: 1,0/1,5 mm.

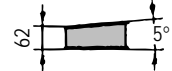

5° bend, grey.
122 020 140



15° bend, grey.
122 020 118

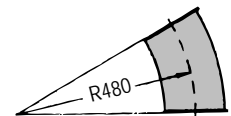

30° bend, grey.
122 020 113

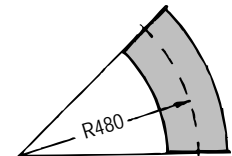

45° bend, grey.
122 020 108

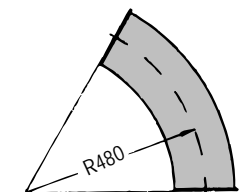

60° bend, grey.
122 020 103

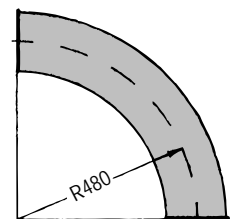

90° bend, grey.
122 020 096

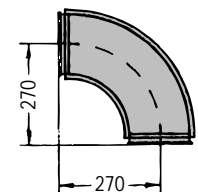

90° bend, grey.
R = 240 (for ventilation only).
Thickness of sheet: 1 mm
122 020 094

OK 160

Diverter

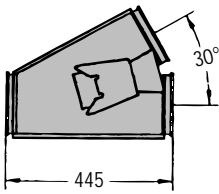

30° 2-way diverter, grey.
122 000 690

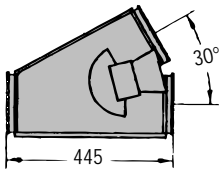

30° 2-way diverter, grey.
Pneumatic operated, w/o cylinder.
122 000 697



Pneumatic cylinder for 30° 2-way diverter.
122 000 639

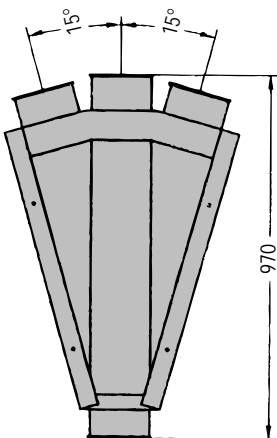

15° 3-way diverter, grey.
122 000 682

Branch pipes

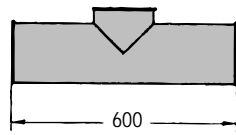

90° branch pipe, grey.
OK 160/100/160
122 000 461

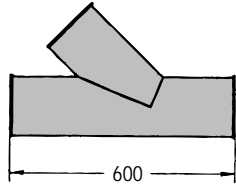

45° branch pipe, grey.
OK 160/100/160
122 000 323

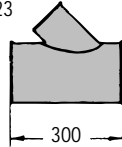

45° branch pipe, grey.
OK 160/100/160.
131 025 052

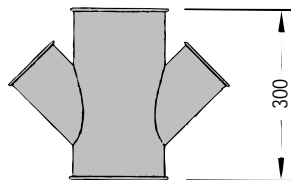

45° OK160 Branch pipe w/2 x OK100
branches, grey.
122 000 805

Pipe supports

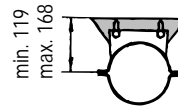

Pipe support, grey.
122 000 702

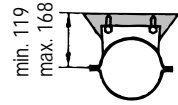

Pipe support, galv.
122 000 360

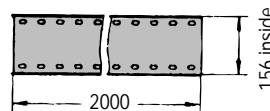

Pipe support extension, galv.
Length 2 m - may be shortened
at will.
131 025 055

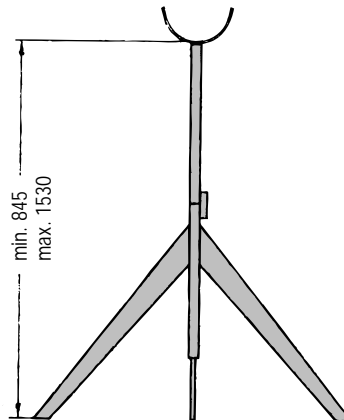

Pipe support, grey.
122 000 705

Shutter



Shutter, blue
(for air regulator).
122 000 689

Transitions



Transitions OK 100/160, gray.
122 000 308

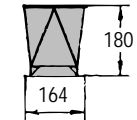

OK 160 adaptor with square flange,
blue.
122 000 003

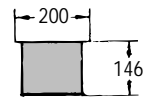

OK 160 adaptor with square flange,
blue.
110 101 109

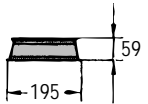

OK 160 adaptor with flange, grey.
121 000 549

Welding adaptors

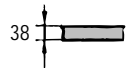

OK 160 welding adaptor, unpainted.
1 mm sheet
122 000 592



OK 160 welding adaptor, unpainted.
2 mm sheet
122 020 054

Exhaust head

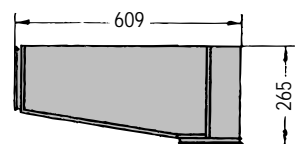

Exhaust head, galv.
122 000 688

Deflector

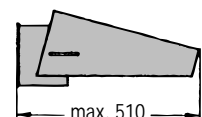

Deflector, grey.
122 000 684

OK 160

Cyclones

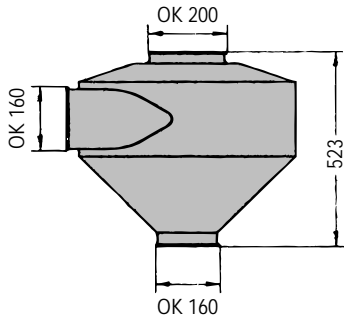

UC cyclone, galv.
(exhaust cyclone).
122 000 698

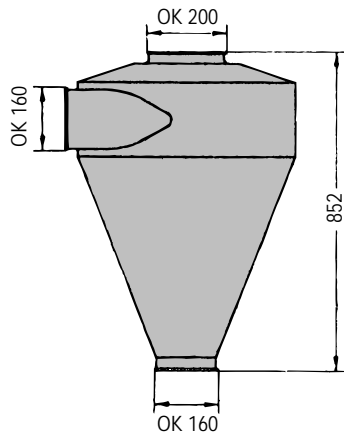

RC cyclone, galv.
(dust cyclone).
131 000 047

Steel flex. hose

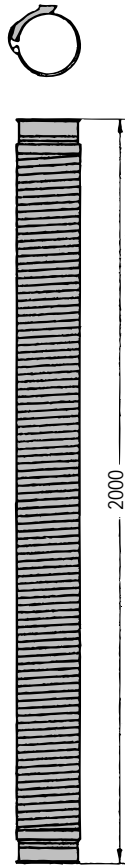

Steel flex. hose
(with quick release clamp).
121 000 639

Flexible polyurethane hoses

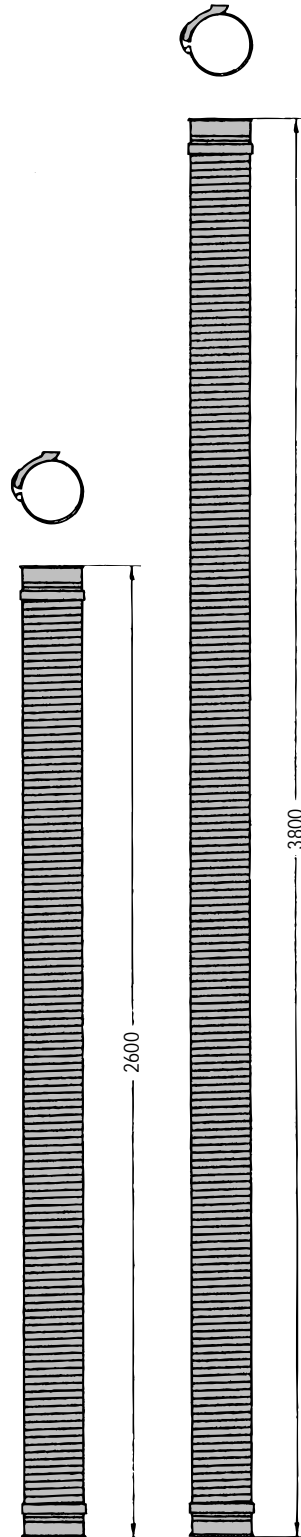

Flexible polyurethane hose
(with quick release clamp).
121 000 645

Flexible polyurethane hose
(with quick release clamp).
121 000 650

Rubber socket



Rubber socket
(for sealing of OK 160 joint).
122 001 001

Silencer

The conveyed material may not pass through the silencer.

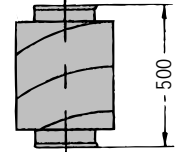

Silencer, galv.
125 500 544

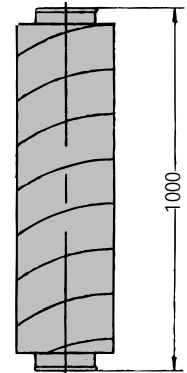

Silencer, galv.
125 500 552

OKR 160

Pneumatic Conveying Reinforced Pipe System

Outer diameter: 160 mm.

Clamps



Quick release clamp, grey.
122 000 780



Quick release clamp, galv.
122 000 800



Clamp with bolt, galv.
122 000 193



Bolt/quick release clamp,
blue.
122 000 648

Pipes

Thickness of sheet: 1,25 mm.

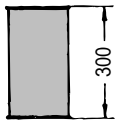

0,3 m pipe, galv.
122 010 043

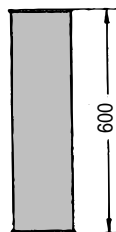

0,6 m pipe, galv.
122 010 042

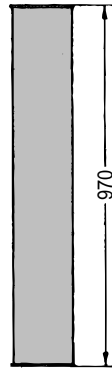

1 m pipe, galv.
122 010 041

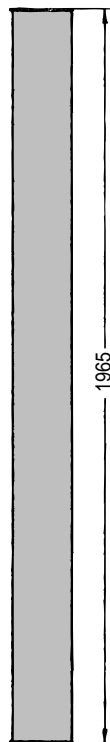

2 m pipe galv.
122 010 040

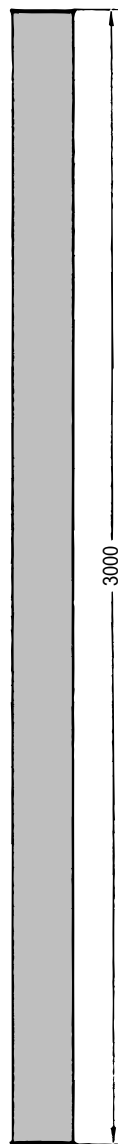

3 m pipe, galv.
122 010 079

Telescopic pipe

Thickness of sheet: 1,25 mm

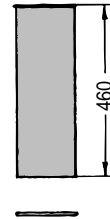

0,5 m telescopic pipe, galv.
122 000 694



O-ring
122 000 132

Bends

Thickness of sheet: ins./outs.: 1,0/2,5 mm.



15° bend, galv.
122 020 137

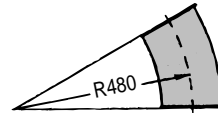

30° bend, galv.
122 020 134

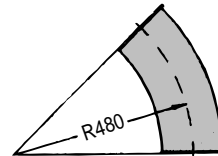

45° bend, galv.
122 020 131

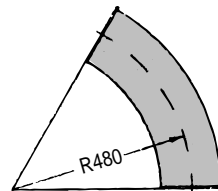

60° bend, galv.
122 020 128

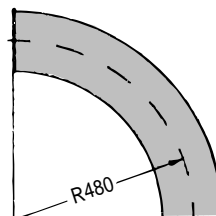

90° bend, galv.
122 020 124

Pipe supports

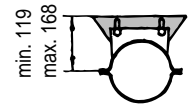

Pipe support, grey.
122 000 702

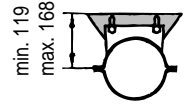

Pipe support, galv.
122 000 360

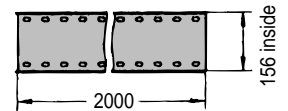

Pipe support extension, galv.
Length 2 m - may be shortened
at will.
131 025 055

Cyclones

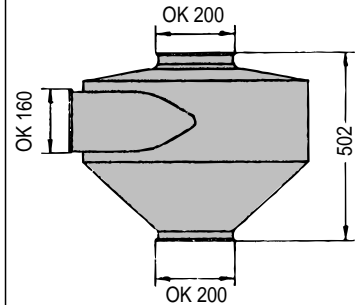

UC cyclone, grey.
(exhaust cyclone with OK 160 quick
release clamp).
122 000 687

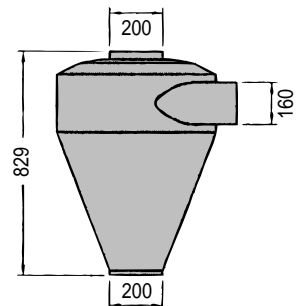

IC cyclone 20°, grey.
(w/interchangeable filter).
131 025 101

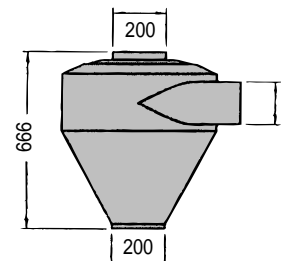

IC Cyclone 30°, grey
(w/interchangeable filter).
121 000 719

OKD 160

Downpipe System

Outer diameter: 160 mm.

Clamps



Quick release clamp, grey.
122 000 780



Quick release clamp, galv.
122 000 800



Clamp with bolt, galv.
122 000 193



One head quick release clamp,
blue.
122 000 648

Pipe

Thickness of sheet: 2 mm.

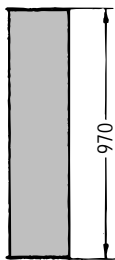

1 m pipe, galv.
122 010 044

Bends

Thickness of sheet: ins./outs.: 1,5 mm.

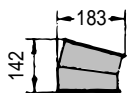

15° bend, grey.
122 022 012

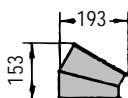

30° bend, grey.
122 022 013

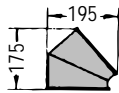

45° bend, grey.
122 022 008

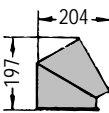

60° bend, grey.
122 022 014

Diverter

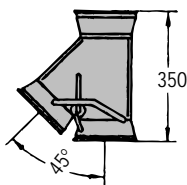

45° 2-way diverter, grey.
122 000 692

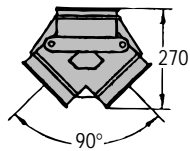

90° 2-way diverter, grey.
124 000 014

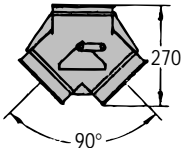

90° 2-way diverter, grey.
Pneumatic operated, incl. cylinder.
124 000 084

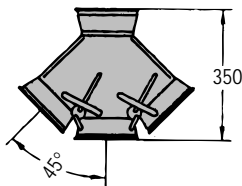

45° 3-way diverter, grey.
122 000 693

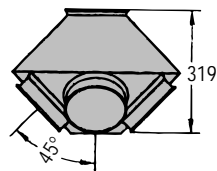

45° 4-way diverter, grey.
122 000 683

Overflow

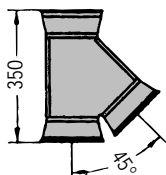

Overflow, grey.
122 000 496

Pipe supports

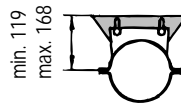

Pipe support, grey.
122 000 702

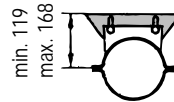

Pipe support, galv.
122 000 360

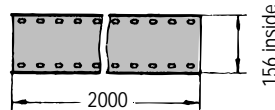

Pipe support extension, galv.
Length 2 m - may be shortened
at will.
131 025 055

Shutter



Shutter, grey.
122 000 685

Shutter seal
131 025 028



Shutter, grey.
Pneumatic operated,
incl. cylinder.
122 000 686

Shutter seal
131 025 028

Shutter



Same as OKD 200
124 050 008

Transition



Transition OKD 160/200, grey
121 000 367

Swivel spout

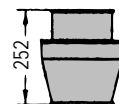

Swivel spout, grey.
Max. discharge angle is 35°
124 000 083

Steel flex. hose

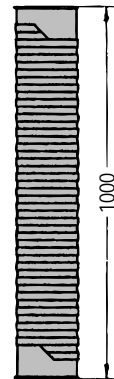

1 m flex. steel hose.
122 000 197

Hoppers

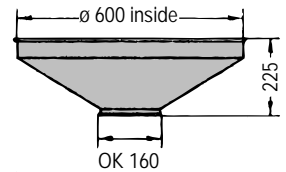

Hopper (w/o intake guard), blue.
122 000 470

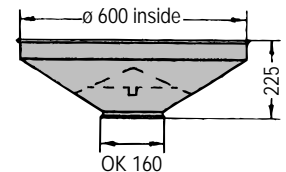

Hopper (with intake guard), blue.
121 100 135

Extension hopper

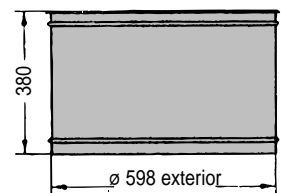

Extension hopper, blue.
122 000 013

Rubber adaptor

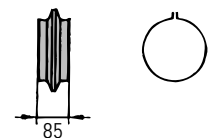

Rubber adaptor
(with 2 clamps).
122 000 026

OK 200

Pneumatic Conveying Exhaustion Ventilation

Outer diameter: 200 mm.

Clamps



Quick release clamp, grey.
122 050 101



Quick release clamp, galv.
122 050 150



Clamp with bolt, grey.
122 050 110

Pipes

Thickness of sheet: 0,9 mm.

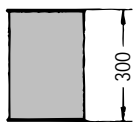

0,3 m pipe, galv.
122 050 086

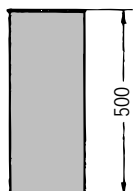

0,5 m pipe, galv.
122 050 085

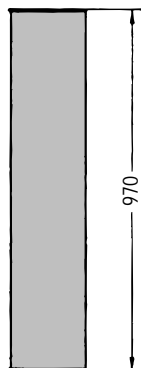

1 m pipe galv.
122 050 084

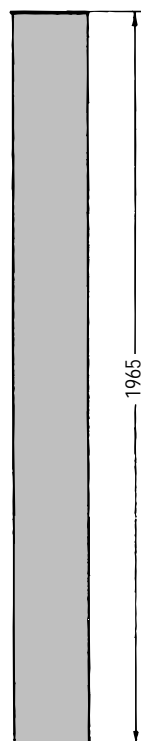

2 m pipe, galv.
122 050 083

Telescopic pipe

Thickness of sheet: 0,9 mm.

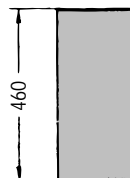

0,5 m telescopic pipe, galv.
122 050 106

O-ring
122 000 850

Bends

Thickness of sheet: 0,9 mm.

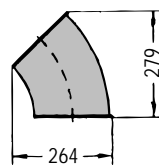

45° bend, galv.
R = 300
122 050 115

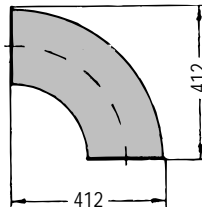

90° bend, galv.
R = 300
122 050 116

Pipe support

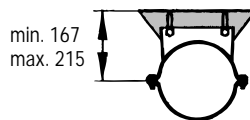

Pipe support, galv.
122 050 134

Shutter



Shutter, blue.
(for air regulator).
122 050 117

Cyclone

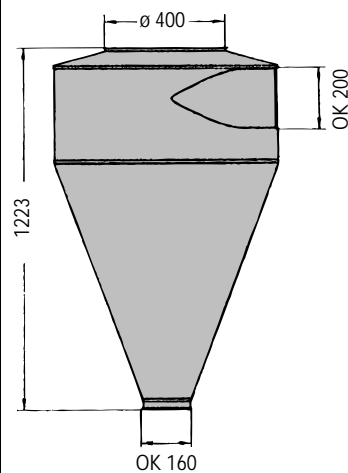

RC cyclone, blue.
(dust cyclone).
131 020 099

OKD 200

Downpipe System

Outer diameter: 200 mm.

Clamps



Quick release clamp, grey.
122 050 101



Quick release clamp, galv.
122 050 150



Clamp with bolt, grey.
122 050 110

Pipes

Thickness of sheet: 2 mm.



0,15 m pipe, grey.
122 000 455

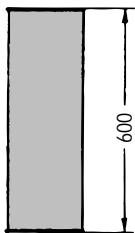

0,6 m pipe, grey.
122 050 043

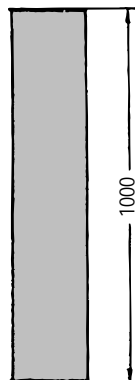

1 m pipe, grey.
122 050 044

Telescopic pipe

Thickness of sheet: 2 mm.

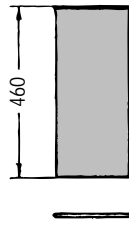

0,5 m telescopic pipe, grey.
122 050 132

O-ring
122 000 850

Bends

Thickness of sheet: ins./outs.: 2 mm.

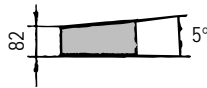

5° bend, grey.
122 050 016

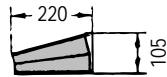

15° bend, grey.
122 050 019

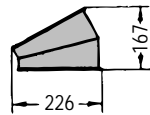

30° bend, grey.
1,5 mm sheet.
122 050 087

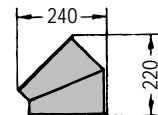

45° bend, grey.
122 050 017

Diverter

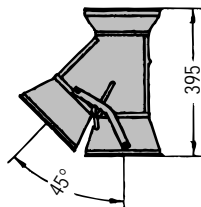

45° 2-way diverter, grey.
122 050 130

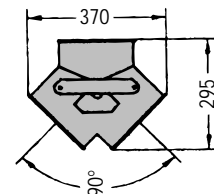

90° 2-way diverter, grey.
122 050 006

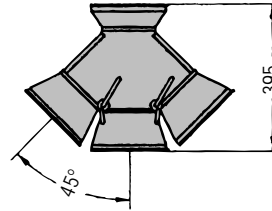

45° 3-way diverter, grey.
122 050 131

Overflow

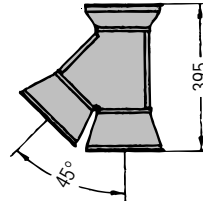

Overflow, grey.
122 050 035

Shutter



Shutter, grey.
121 106 096

Shutter



Shutter, grey.
(for discharge, may be operated from a distance).
124 052 045

Transitions

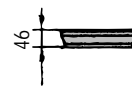

Transition Ø 180/OKD 200, grey.
121 000 629



Transition OKD 200/250, grey.
122 050 075

Swivel spout

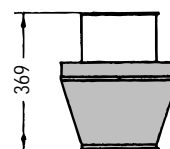

Swivel spout, grey.
Max. discharge angle is 35°
122 050 133

Steel Flex hose

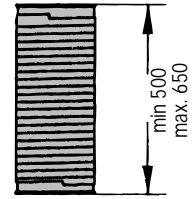

0,5 m flex steel hose.
122 050 156

Hoppers

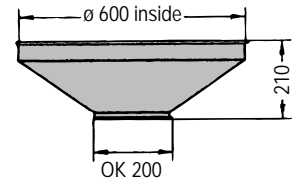

Hopper (w/o intake guard), blue.
122 050 051

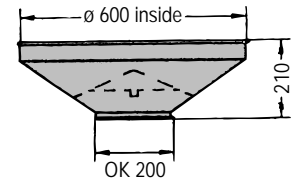

Hopper (with intake guard), blue.
121 106 071

Extension hopper

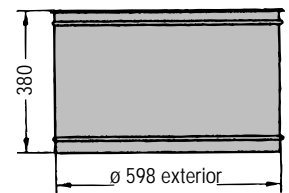

Extension hopper, blue.
122 000 013

Pipe support

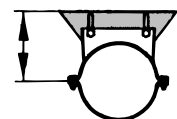

Pipe support, galv.
122 050 134



Kongskilde U.K. Ltd.
Hempstead Road, Holt
Norfolk NR 25 6 EE
Great Britain
Phone: +44 12 63 713291
Fax: +44 12 63 712922
E-mail: mail@kuk.kongskilde.com

Kongskilde South Africa (Pty) Ltd.
194 Main Road, Anderbolt
Boksburg North (Johannesburg)
P.O. Box 6146
Dunswart 1508
South Africa
Phone: +27 11 894 234 1
Fax: +27 11 894 619 4
E-mail: mail@ksa.kongskilde.com



Kongskilde Industries A/S
DK-4180 Sorø, Denmark
Tel. +45 57 86 50 00
Fax. +45 57 86 51 00
E-mail: mail@kongskilde.com
www.kongskilde.com